

This drawing contains information which is the property of Woodgrain Millwork, Inc. This drawing is received on confidence and contents may not be disclosed without the prior written consent of Woodgrain Millwork, Inc.

4605

Draw #:	Shaker 4605_36_80	
Date:	10 - 16 - 14	R1
Drawn By:	T Doughty	

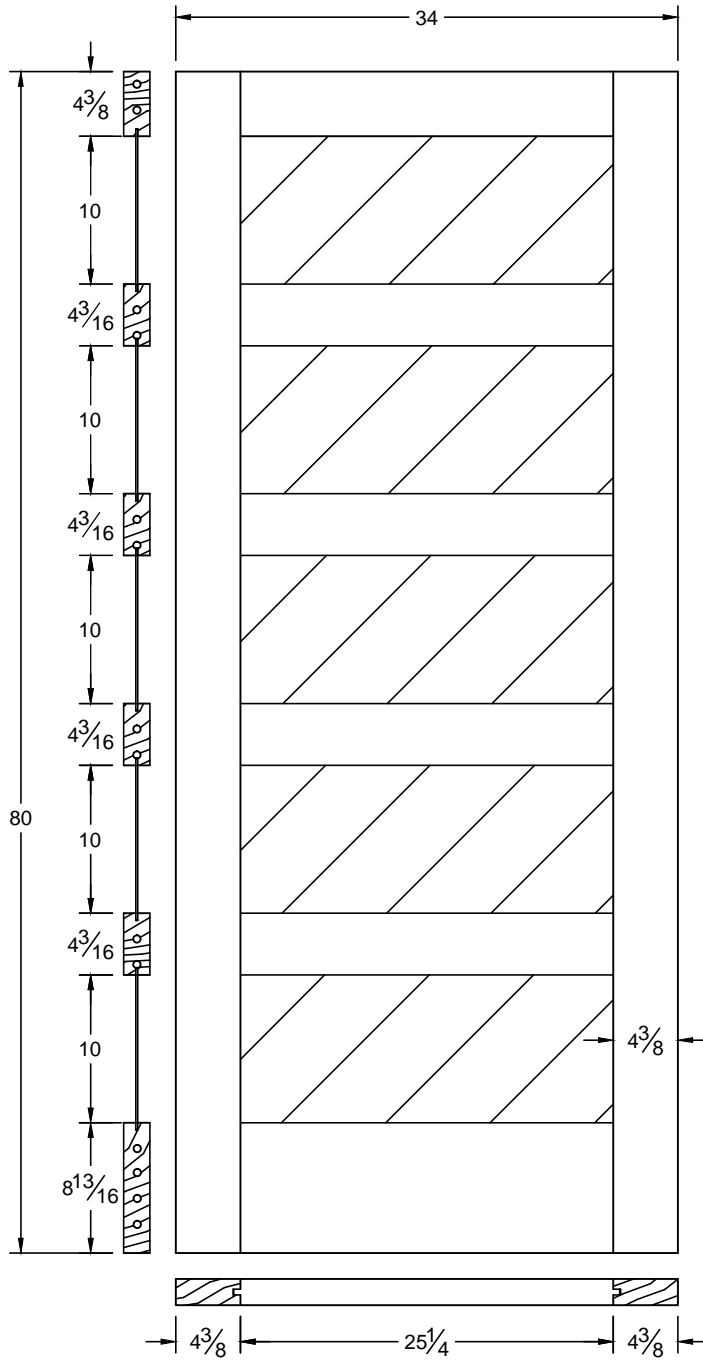



This drawing contains information which is the property of Woodgrain Millwork, Inc. This drawing is received on confidence and contents may not be disclosed without the prior written consent of Woodgrain Millwork, Inc.

4605

Draw #:	Shaker 4605_34_80	
Date:	10 - 16 - 14	R1
Drawn By:	T Doughty	



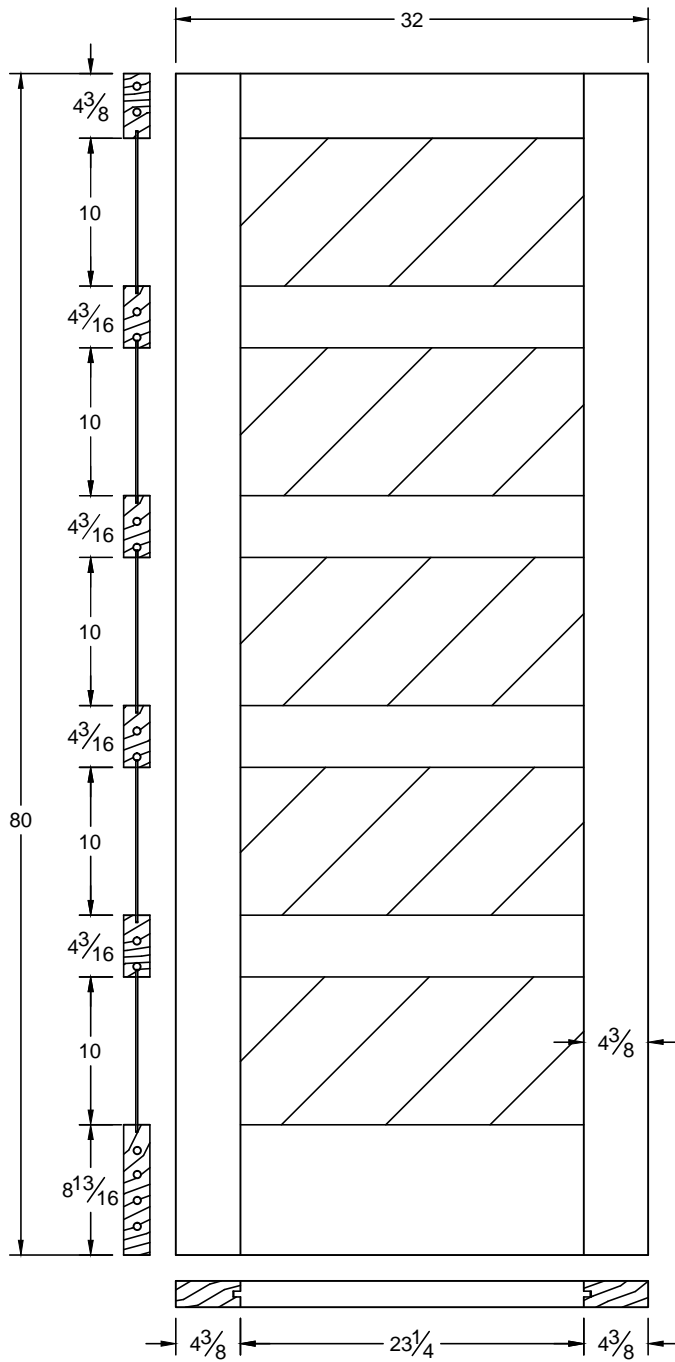

This drawing contains information which is the property of Woodgrain Millwork, Inc. This drawing is received on confidence and contents may not be disclosed without the prior written consent of Woodgrain Millwork, Inc.

4605

Draw #:	Shaker 4605_32_80	
Date:	10 - 16 - 14	R1
Drawn By:	T Doughty	



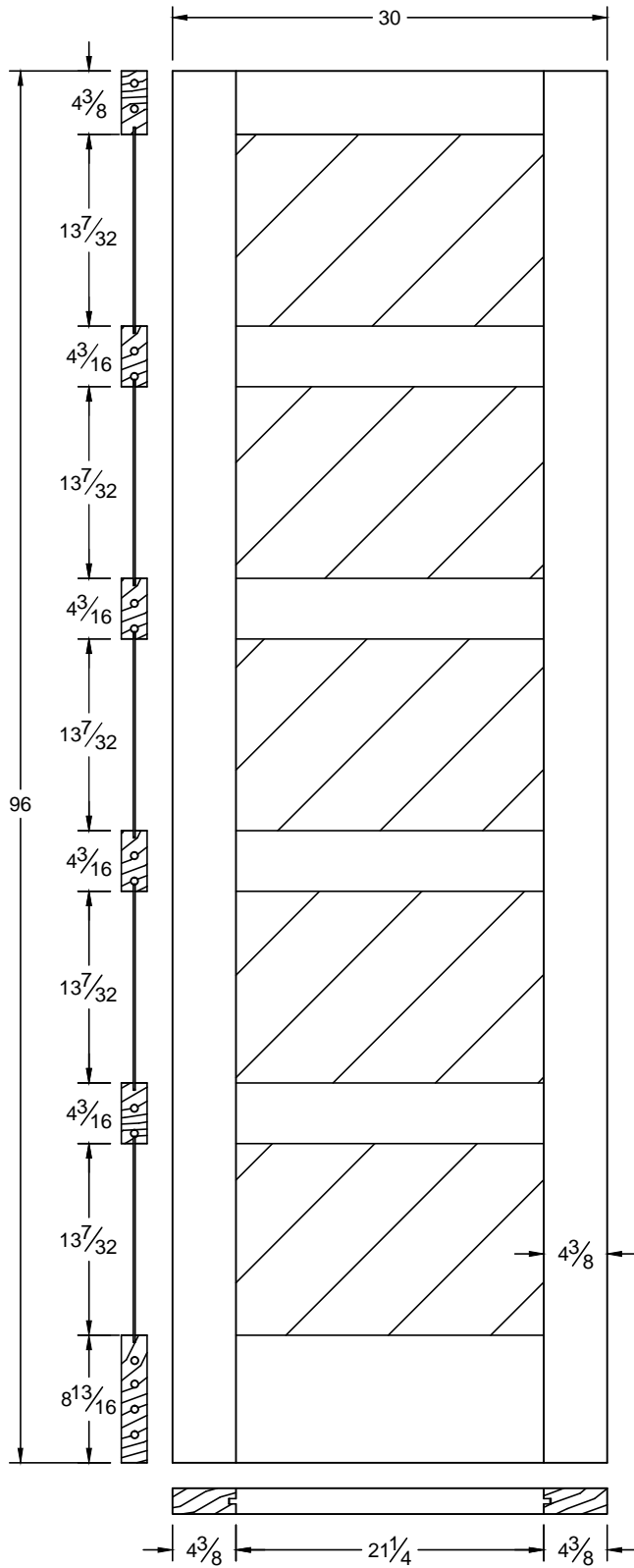

This drawing contains information which is the property of Woodgrain Millwork, Inc. This drawing is received on confidence and contents may not be disclosed without the prior written consent of Woodgrain Millwork, Inc.

4605

Draw #:	Shaker 4605_30_80	
Date:	10 - 16 - 14	R1
Drawn By:	T Doughty	



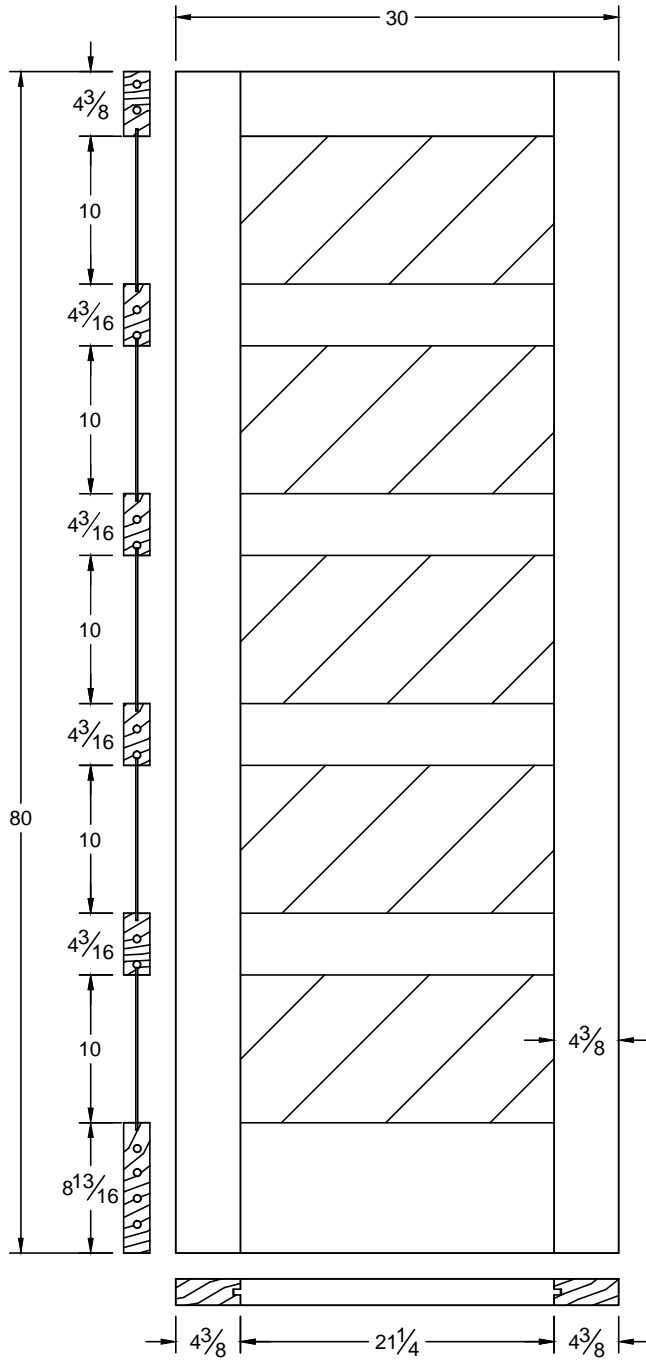

This drawing contains information which is the property of Woodgrain Millwork, Inc. This drawing is received on confidence and contents may not be disclosed without the prior written consent of Woodgrain Millwork, Inc.

4605

Draw #:	Shaker 4605_30_80	
Date:	10 - 16 - 14	R1
Drawn By:	T Doughty	



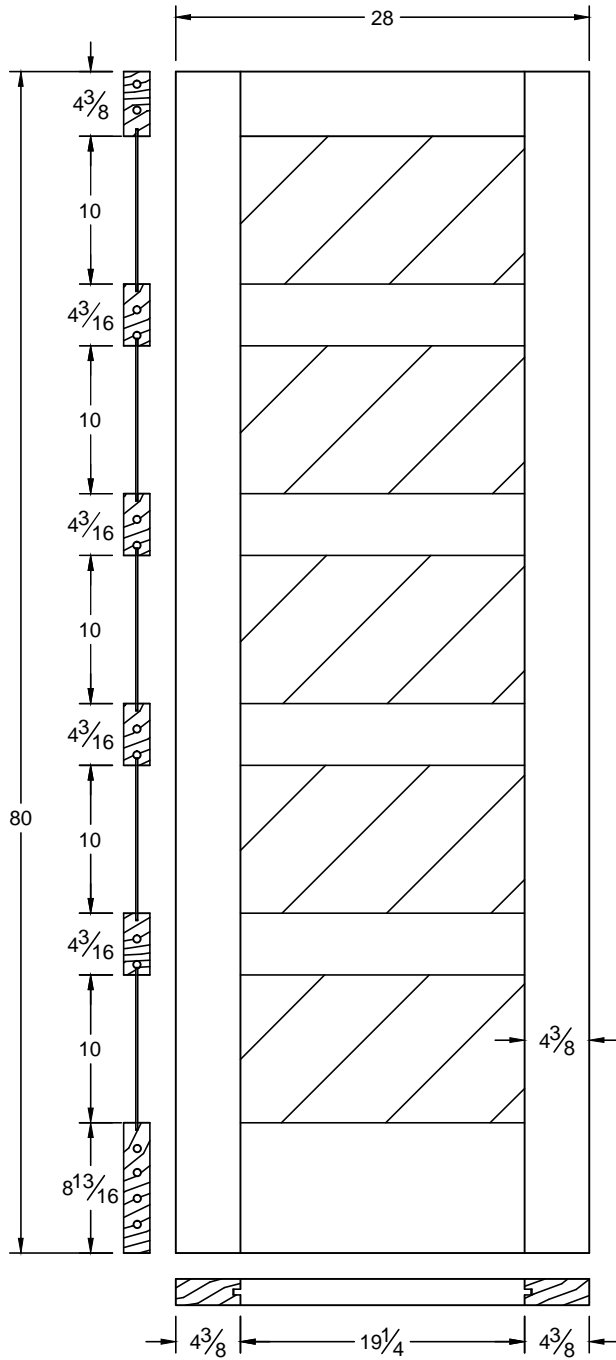

This drawing contains information which is the property of Woodgrain Millwork, Inc. This drawing is received on confidence and contents may not be disclosed without the prior written consent of Woodgrain Millwork, Inc.

4605

Draw #:	Shaker 4605_28_80	
Date:	10 - 16 - 14	R1
Drawn By:	T Doughty	



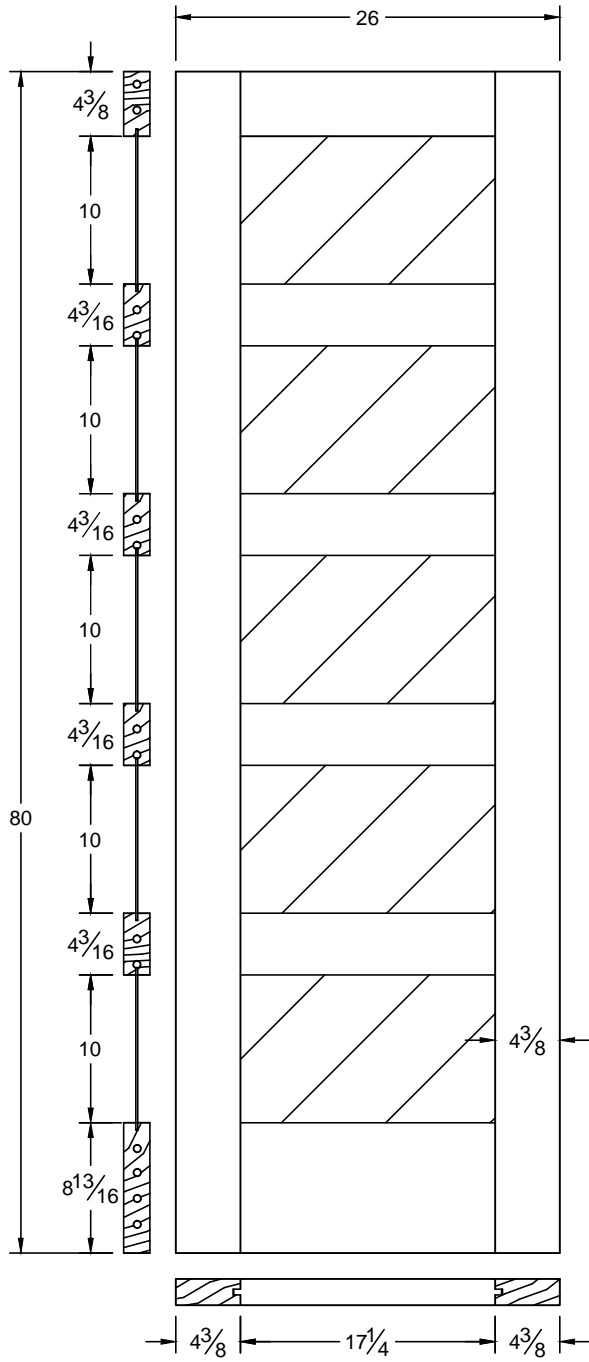

This drawing contains information which is the property of Woodgrain Millwork, Inc. This drawing is received on confidence and contents may not be disclosed without the prior written consent of Woodgrain Millwork, Inc.

4605

Draw #:	Shaker 4605_26_80	
Date:	10 - 16 - 14	R1
Drawn By:	T Doughty	



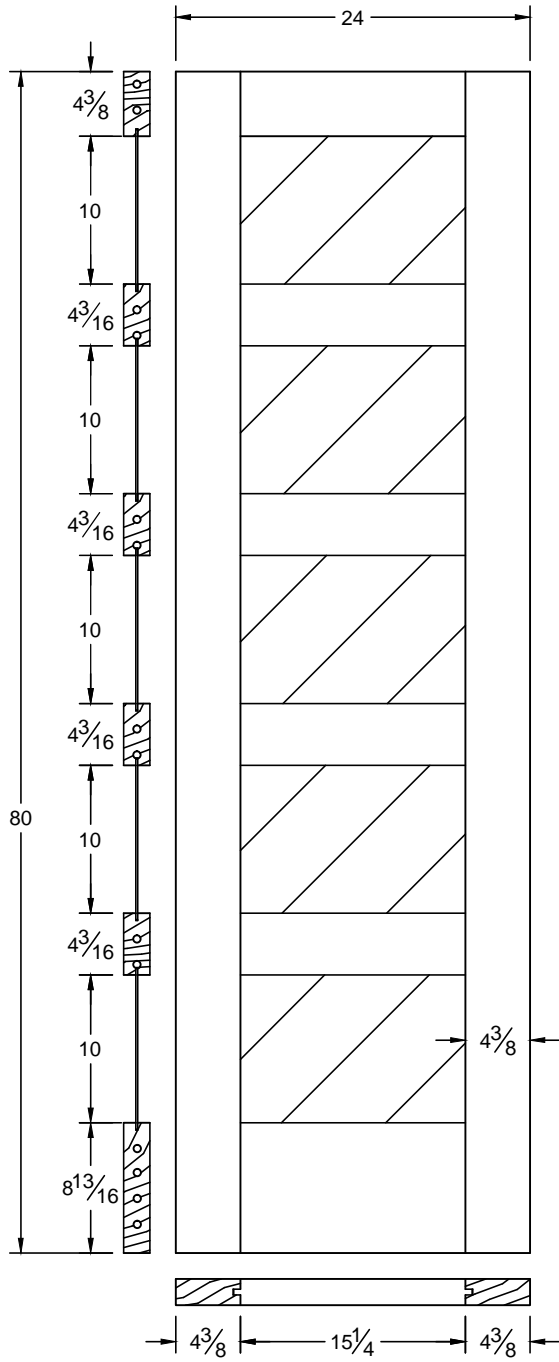

This drawing contains information which is the property of Woodgrain Millwork, Inc. This drawing is received on confidence and contents may not be disclosed without the prior written consent of Woodgrain Millwork, Inc.

4605

Draw #:	Shaker 4605_24_80	
Date:	10 - 16 - 14	R1
Drawn By:	T Doughty	



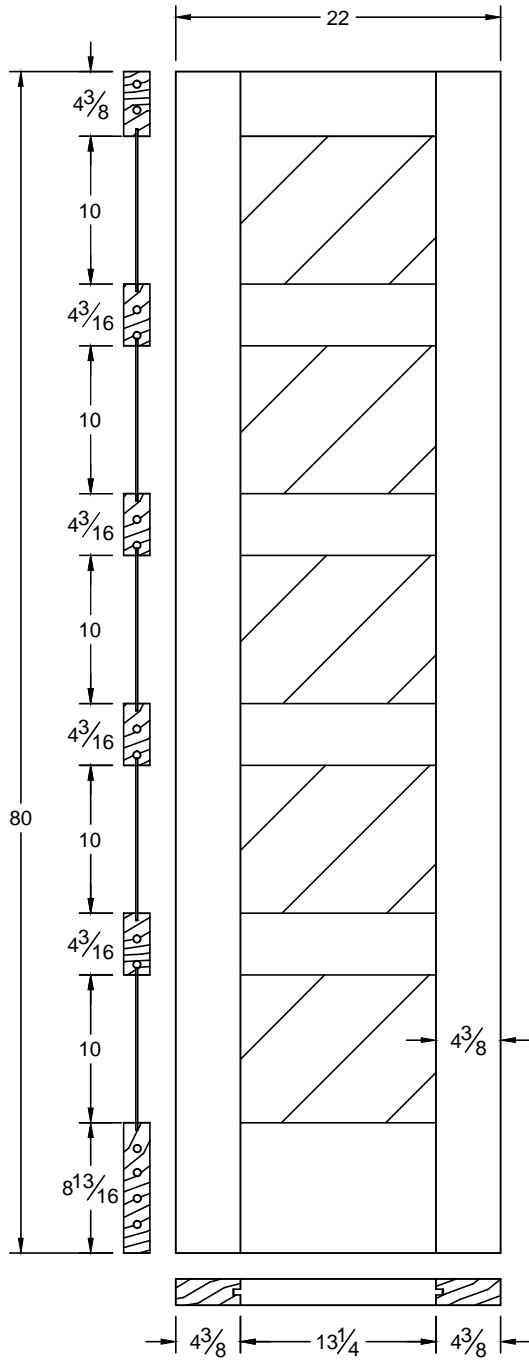

This drawing contains information which is the property of Woodgrain Millwork, Inc. This drawing is received on confidence and contents may not be disclosed without the prior written consent of Woodgrain Millwork, Inc.

4605

Draw #:	Shaker 4605_22_80	
Date:	10 - 16 - 14	R1
Drawn By:	T Doughty	



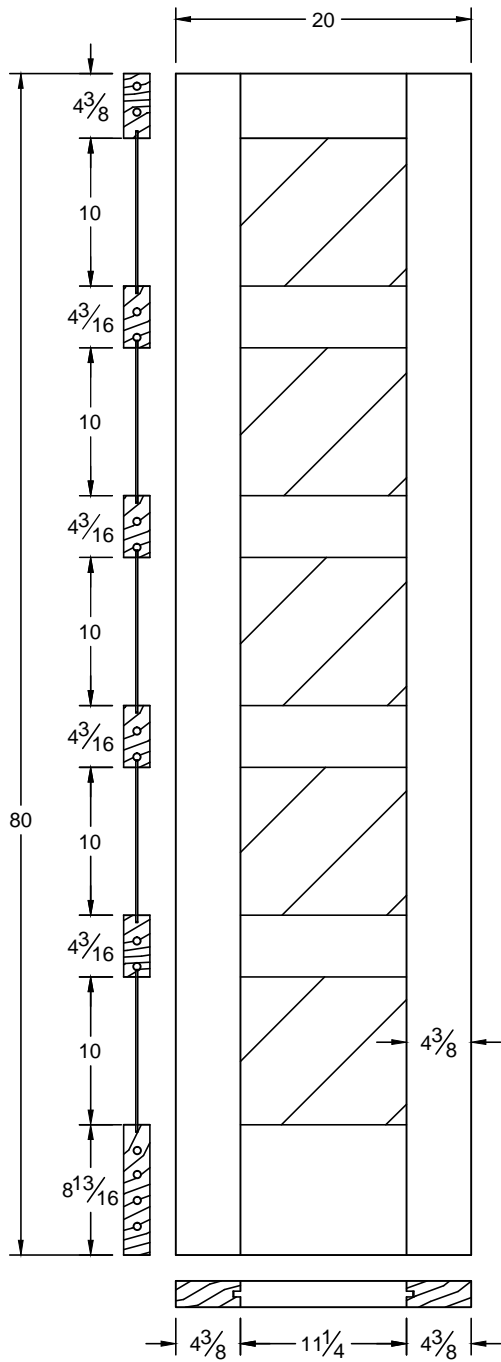

This drawing contains information which is the property of Woodgrain Millwork, Inc. This drawing is received on confidence and contents may not be disclosed without the prior written consent of Woodgrain Millwork, Inc.

4605

Draw #:	Shaker 4605_20_80	
Date:	10 - 16 - 14	R1
Drawn By:	T Doughty	

